



TRUE HEPA AIR
PURIFIER

User Manual

P200S

READ AND SAVE THESE
INSTRUCTIONS



CONTENTS

IMPORTANT SAFETY INSTRUCTIONS	01
WHAT'S INCLUDED	04
KNOW YOUR AIR PURIFIER	04
Product Overview	04
Control Panel	06
Filtration	07
SPECIFICATIONS	07
GET STARTED	08
USE YOUR AIR PURIFIER	09
On/Off	09
Sleep Mode	10
Night Light	10



Auto Mode	10
PM2.5 Display	11
Timer	11
Fan Speed	12
Child Lock	13
Filter Replacement	14
Displays Error	14
MAINTENANCE AND CARE	14
Clean The Air Purifier	14
Replace the HEPA&Activated Carbon Filter	16
Storage	16
TROUBLESHOOTING GUIDE	17

IMPORTANT SAFETY INSTRUCTIONS

Warning

Users should only operate the air purifier once they have understood all the following important safety instructions. Users who have a disability and need assistance are responsible for seeking support and ensuring their own safety in line with the instructions given in this manual.

2.To Reduce The Risk Of Fire Or Electric Shock, Do Not Use This Fan With Any Solid-State Speed Control Device.



Moving

* Turn off and unplug the air purifier before moving it.

1.This appliance has a polarized plug (one blade is wider than the other). To reduce the risk of electric shock, this plug is intended to fit in a polarized outlet only one way. If the plug does not fit fully in the outlet, reverse the plug. If it still does not fit, contact a qualified electrician. Do not attempt to defeat this safety feature.

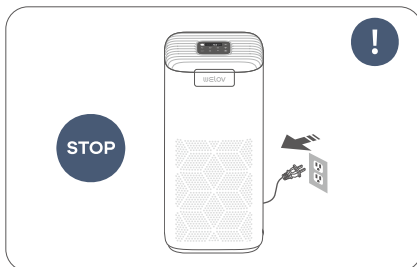

Installation

* Keep a distance of at least **38cm/15inches** between the air inlets and walls or other objects.

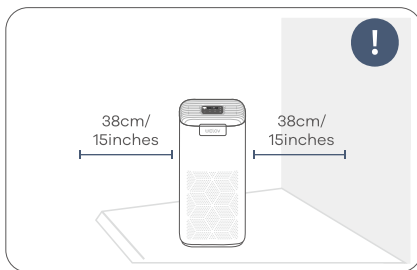

Essential Oils

Do not add **Essential oils** to the air purifier or filter. The filter will become damaged by the oil and will eventually release an unpleasant smell. Do not use diffusers near the air purifier.

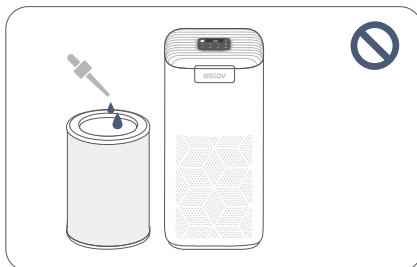

Where in Use

* Do not put your **Fingers** or other objects into the air inlet, air outlet, or filter compartment.

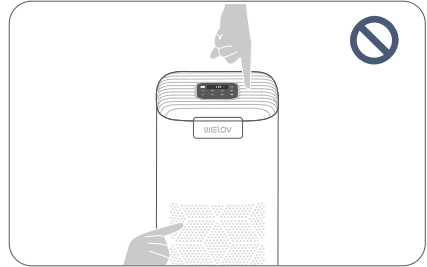

* Keep hair or cloth away from the air purifier to avoid them getting into and **Blocking** the inlet/outlet.



* Please do not sit on, lean on, or tilt the air purifier.



* Always place the air purifier out of the reach of patients, children, or pets.

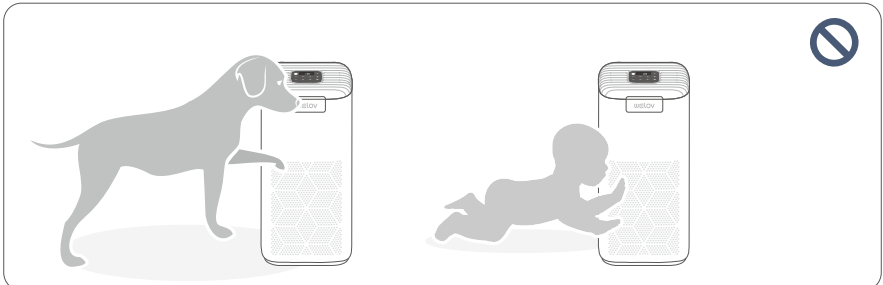

* Please keep your air purifier away from any heat sources, such as stove, oven, electric heater, etc.

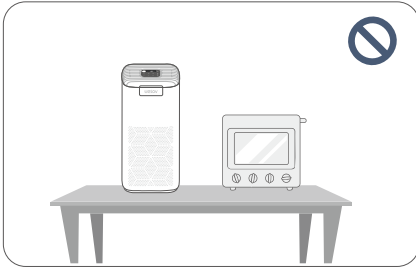

* Children should be supervised to ensure that they do not play with the appliance.

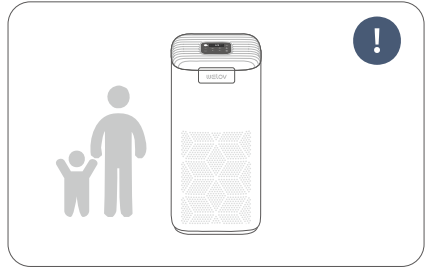

* do not place the air purifier on any uneven surfaces where it can easily fall over.

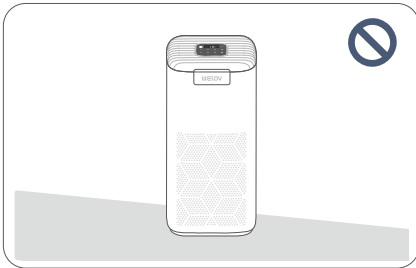

* To Reduce The Risk Of Fire Or Electric Shock, Do not Use This Fan With Any Solid-State Speed Control Device."



* do not use the air purifier in **Bathrooms** or other places that are hot or over.

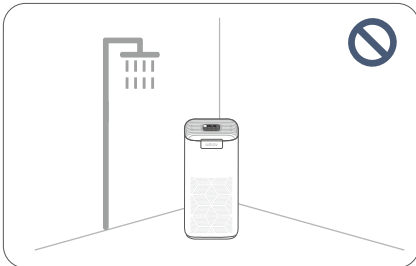

* do not use your air purifier **Outdoors**. It's for household use only.

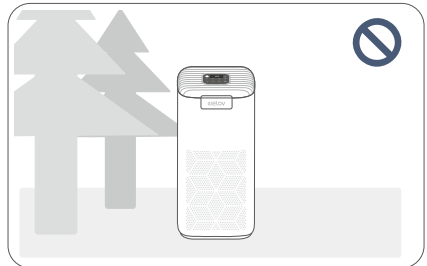

Welov will accept no liability or responsibility for fires or electrical shocks caused by improper operation or not adhering to the above safety instructions.

WHAT'S INCLUDED



Air purifier x1



Replace the HEPAS&Activated Carbon Filter x1



User Manual x1



Quick Guide x1

KNOW YOUR AIR PURIFIER

PRODUCT OVERVIEW

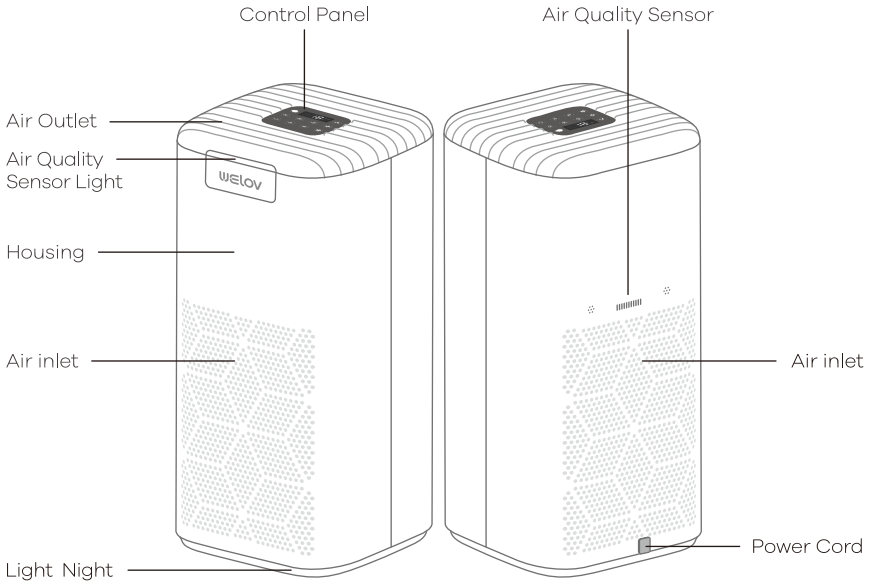

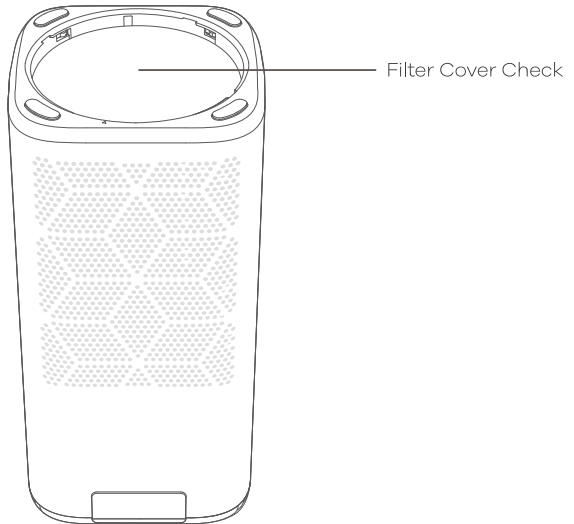
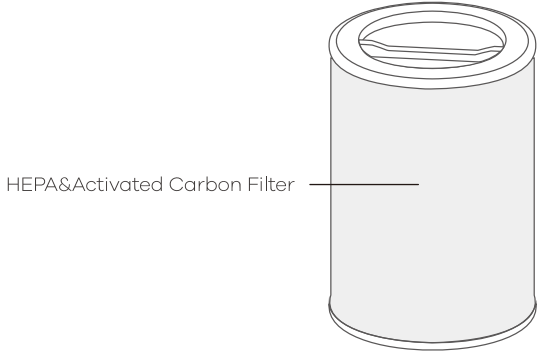
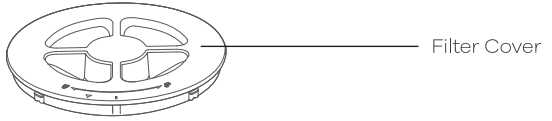

Upside Down

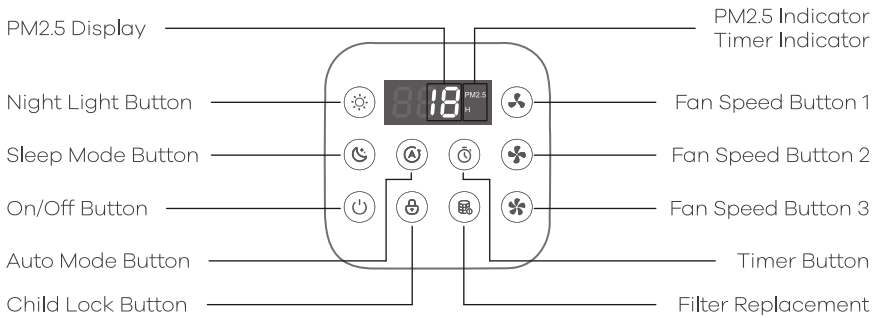

CONTROL PANEL



On/Off Button

* Turns the air purifier on/off.



Sleep Mode Button

* Turns Sleep Mode on/off.



Night Light Button

* Turns Night Light on/off and adjust the brightness.



Auto Mode Button

* Automatically adjust wind speed to purify air according to air quality.



Timer Button

* Set the time duration to automatically power off the air purifier.



Filter Replacement

* Light up when the air filter should be checked.



Child Lock Button

* Prevent the current settings from being changed accidentally by children or pets.

Fan Speed Buttons

* 3 fan speeds button options:



Low (Fan Speed Button 1 indicate will light up),



Medium (Fan Speed Button 2 indicate),



High (Fan Speed Button 3 indicate).

FILTRATION SYSTEM

The air purifier's filtration system consists of the Pre-filters and the HEPA&Activated Carbon Filter.

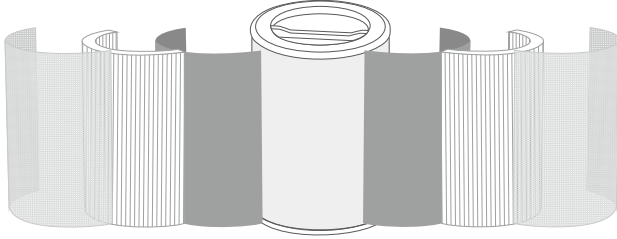

1. Pre-filters

> The pre-filters can filter large particles such as dust, lint, fibers, hair, and pet hair.

2. True HEPA Filter

HEPA

> Filter out particles **0.1 Microns** in diameter from at least **99.7%** of the air

> The HEPA can filter small particles such as smoke, dust, mold spores, bacteria, viruses, and allergens such as pollen, pet dander, and dust mites.

3. Activated Carbon Filter

> This layer is to deal with odors or smoke.

> This layer can also filter the organic compound such as **Formaldehyde, Ammonia, Hydrogen Sulfide**, and volatile organic compound(VOCs).

• Temperature Conditions for Using the Filter

> Excessive moisture may damage the filter. The air purifier should be used in an area with a humidity level below 85% RH. If you use the air purifier in excessively humid areas, the surface of the filter part will become moldy.

SPECIFICATIONS

Model	P200S	CADR	205CFM/350m ³ /h
Voltage Input	AC 120V,60Hz	Room Size	315ft ² /30m ²
Rated Power	45W	Noise Level	≤ 55dB
Standby Power	<1W	Dimension	240*240*504mm/ 9.44*9.44*19.84in ches
Net Weight	4.2kg / 148oz		

GET STARTED

Step 1:

Flip over the air purifier and open the filter cover.

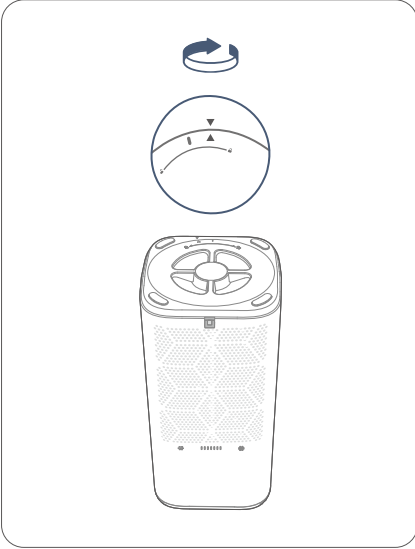

Step 2:

Remove the protective plastic bag from the HEPA&Activated Carbon Filter, and reinstall the filter into the housing.

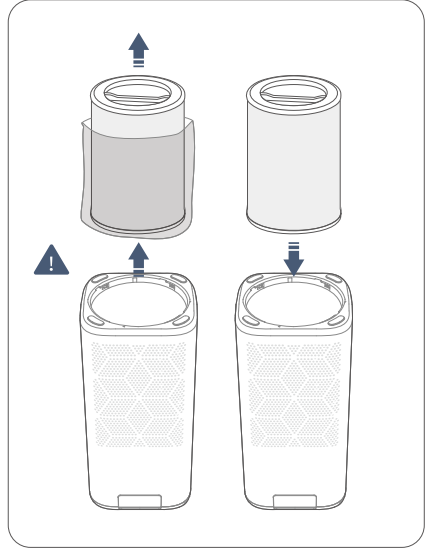

Step 3:

Close the filter cover, and turn over the air purifier to get it ready for use.

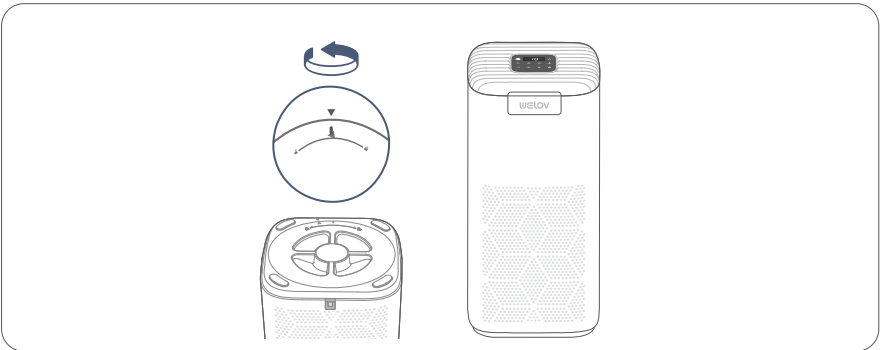

Step 4:

Place the air purifier in a ventilated area and on a level floor. Keep the air inlet facing upwards and maintain a distance of at least **38 cm/15 inches** away from the wall or other objects.

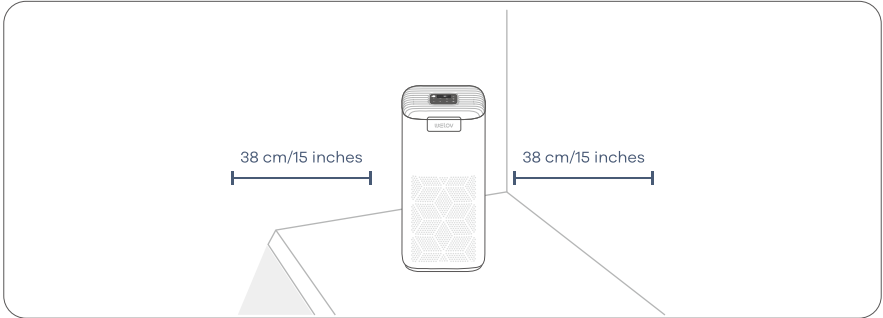

Step 5:

Plug the power cord of the air purifier into the working socket.

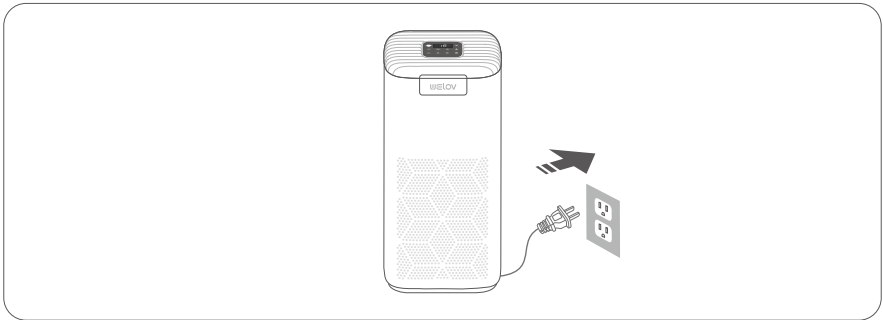

USE YOUR AIR PURIFIER

⏻ ON/OFF



- ① After connecting the air purifier to power, press ⏻ to turn it on, and it will start purifying the air with the default fan speed.
- ② Press ⏻ again to turn off the air purifier.

☾ Sleep Mode



Sleep Mode operates quietly by using a fan speed lower than low speed.

- ① Tap ☾ to turn Sleep Mode on/off.
- ② Sleep Mode will turn off the display after 3 seconds if no other buttons are tapped.

Tips:

- ① In sleep mode, timer adjustment are available. The corresponding indicator will light up for 1s when setting and then turn off.
- ② When the display is turned off, tap any button (except ☾) to turn the display back on. If you don't tap another button, the display will turn off again after 3 seconds.

☼ Night Light



1.5S

This function is to provide illumination for your convenience at night.

- ① Tap ☼ to turn Night Light on/off.
- ② **Tap and hold** ☼ for 1.5s to gradually increase the brightness; release when you get your desired brightness. Tap and hold ☼ it for 1.5s again to decrease the brightness.

Tips:

The air purifier will remember the brightness of the night light if it's plugged in. The brightness will return to the default level if the air purifier is unplugged and turned on again.

Ⓐ Auto Mode



Auto Mode adjusts the fan speed automatically based on air quality. For example, if the air quality is bad, the fan will be set to high speed.

- ① The air purifier will take 10 seconds to detect the air quality each time it is turned on. During this time, the air quality indicator light will be green. After 10 seconds, the air quality indicator lights will change color based on the detected air quality.
- ② Tap Ⓐ again to turn off the Auto Mode.

Air Quality Indicator Chart

Indicator Color	Air Quality	Fan Speed	PM2.5 Range
Green	Good	Low	0-50 ug/m ³
Orange	Moderate	Medium	50-100 ug/m ³
Red	Bad	High	>100 ug/m ³

Tip:

This mode, Tap other speeds button will exit the Auto mode.

PM2.5 Display

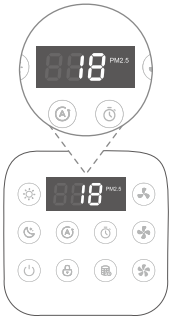

① The **PM2.5** value on the display shows the amount of airborne particles (μg) that are detected per 1 cubic meter (m^3) of air volume. **PM2.5** refers to particulate matter (PM) that is less than or equal to 2.5 microns (μm) in diameter. These particles, also known as “fine particles”, are so small that they can only be detected with an electron microscope, and they stay in the air longer than heavier particles such as dust and mold.

② Your purifier's Infrared Dust Sensor detects the amount of **PM2.5** particles that are in a given space ($\mu\text{g}/\text{m}^3$). Generally, the lower the number, the better your air quality. A number above 150 indicates that there is an unhealthy amount of fine particles in the air.

⌚ Timer

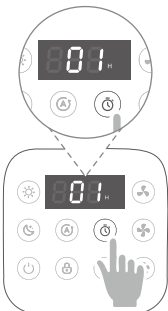

You can set a timer for 1–12 hours.

① Tap ⌚ the display will switch from showing the PM2.5 reading to the time you've selected.

Tips:

Tap and hold ⌚ for 1.5 seconds to cycle through timer options automatically in 1-hour increments.



1.5S

② Tap  repeatedly to select a time in 1-hour increments. If you don't touch any buttons for 3 seconds, the display will switch to showing the PM2.5 reading and the timer will start automatically.

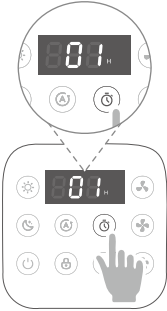

Tips:

The timer indicators are not the buttons to change the timer duration. The air purifier will automatically power off once the timer ends.



③ The timer will count down from your selected time. When the timer is finished, the air purifier will turn off.

Tips:

While a timer is active, tapping  will show the remaining time, rounded up to the nearest hour. Tap  again within 3 seconds to add more time in 1-hour increments.



④ To cancel a timer, tap  repeatedly until the display reads "00".

Tips:

- You can change the fan speed at any time while the timer is on.
- The timer will restart if the time is changed.

Fan Speed



In speed options, we made a more humane split design. There are three speed options for this air purifier, which include Speed1 (low), Speed2 (medium), and Speed3 (high).

Tap  the air purifier will be speed 1 work,  Indicator light on.



Tap  the air purifier will be speed 2 work,  Indicator light on.



Tap  the air purifier will be speed 3 work,  Indicator light on.





Tips:

- The fan speed indicators are not the buttons to adjust the speed.
- The fan speed option of  is the highest level that can purify the air quickly, but it will make louder sounds.
- To effectively purify the air, please close your windows and doors while the air purifier is working. But do ventilate if you are using some combustion equipment, e.g., fireplace or barbecue oven; this is to keep you safe from carbon monoxide.

Child Lock

When the air purifier is on, you can lock the display to prevent settings from being accidentally changed. Buttons will not respond to being tapped.



- ① Tap and hold  for 3 seconds to lock the display. The  indicator will light up in the center of the display.
- ② The  indicator will blink when any other button is tapped to indicate that Display Lock is on.
- ③ Tap and hold  again for 3 seconds to unlock the display. The  indicator will turn off.

Tips:

Display Lock can still be used when the air purifier is in Standby Mode.

Filter Replacement



- ① When the filter is at the end of its service life, the indicator has been flashing to remind you to replace the filter with a new one.
- ② Reset the service time of the new filter after replacement. Please long press  for 3 seconds until the indicator normally on.

Displays Error



When the machine is in operation, opening the screen cover will give an alarm, the button is invalid, the indicator light flashes, and the display screen is in "E1" state. After closing, it will return to normal.

MAINTENANCE AND CARE

Filter Frequency	Cleaning Frequency	Replacing
Pre-filter	Every 2-4 weeks	/
HEPA&Activated Carbon Filter	/	3-6 months

CLEAN THE AIR PURIFIER

Step 1:
Unplug the air purifier before cleaning.

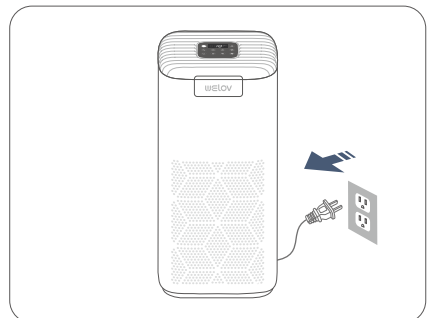

Step 2:

Wipe clean the air purifier's housing with a soft, dry cloth or brush. If necessary, wipe clean the housing with a damp cloth and dry it immediately.



Step 3:

Turn over the air purifier, open the filter cover, then take out HEPA&Activated Carbon Filter.

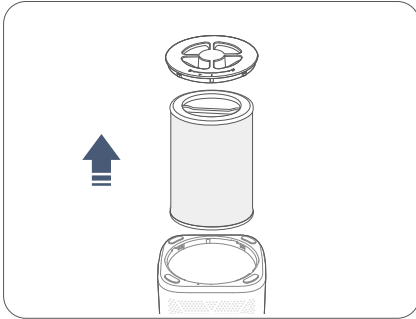

Step 4:

Vacuum inside the filter compartment.

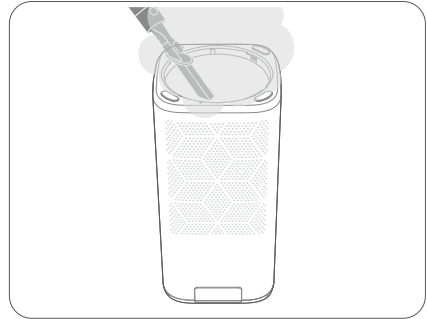

Step 5:

Vacuum the pre-filters, or wipe them with a damp cloth and make them dry completely.



Step 6:

Reinstall the HEPA&Activated Carbon Filter into the air purifier, then close the cover.

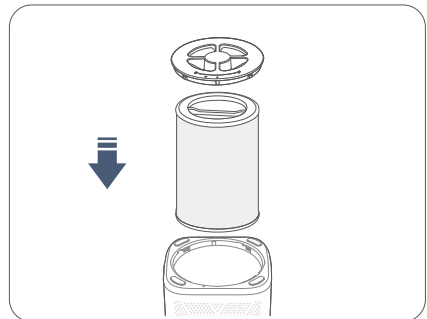

Notes:

- If the pre-filters are not cleaned sufficiently, gently wash them under the water with a soft brush. DO NOT reinstall them into the air purifier before they dry completely.
- Do not clean any parts with abrasive chemicals or flammable agents.
- Do not wash the HEPA&Activated Carbon Filter, as this may damage it.

REPLACE THE HEPA&ACTIVATED CARBON FILTER

- > Generally, the HEPA&Activated Carbon Filter should be replaced every 3-6 months. If the air purifier is frequently used in an environment with relatively high pollution, you will need to replace the HEPA&Activated Carbon Filter more often.
- > The indicator (🕒) will light up in white to remind you to replace the **HEPA&Activated Carbon Filter**.
- > You may need to replace the HEPA&Activated Carbon Filter if you notice:
 - * increased noise when the air purifier is turned on;
 - * decreased airflow from the air outlet;
 - * unpleasant odor from the air outlet;
 - * a visibly clogged and black filter.

Tips:

- To maintain the air purifier's optimal performance, please use the original filter made by Welov. Please contact us to get the purchase link.
- Do not forget to reset the service time of the filter after replacing it.

STORAGE

If the air purifier is not used for an extended period of time, please cover the air purifier and filters with protective plastic bags, then store them in a dry place.

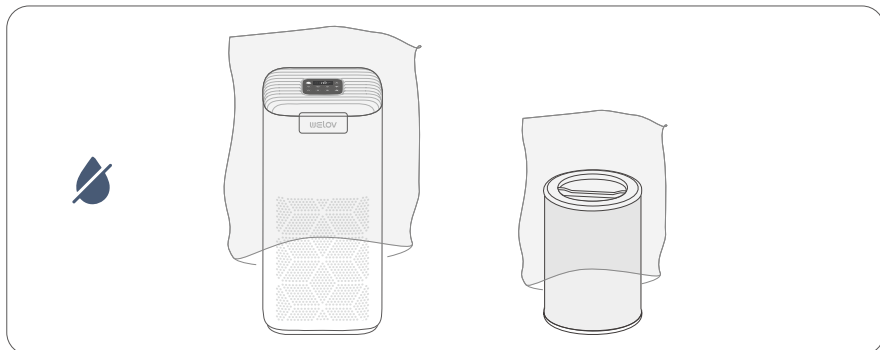

TROUBLESHOOTING GUIDE

If you need any further assistance, please feel free to contact us. To maintain the air purifier's optimal performance, please regularly clean the air purifier and remove objects that block the air inlet.

Problem	Possible Solution
Q1. The air purifier produces an unusual noise after it's turned on.	* Make sure the HEPA&Activated Carbon Filter is removed from the plastic bag and properly installed.
	* Make sure the air purifier is working on a hard, flat, and even surface.
	* The air purifier may be damaged, or there may have foreign objects inside. Please stop using the air purifier and contact us. Do not attempt to repair the air purifier yourself.
Q2. An unpleasant odor is coming from the air purifier.	* Clean the pre-filters, or replace the HEPA&Activated Carbon Filter if necessary.
	* Stop using the air purifier and contact us.
Q3. The air purifier can't be turned on or stops working.	* Check if the air purifier is plugged in.
	* Check if the power cord is damaged. If yes, stop using the air purifier and contact us.
	* Try to plug the air purifier into a different outlet.
	* The air purifier is malfunctioning. Please contact us.
Q4. The air quality is still poor after using the air purifier.	* Make sure the HEPA&Activated Carbon Filter is removed from the plastic bag and properly installed.
	* Tap  to adjust the fan speed to a higher level.
	* Close the doors and windows while using the air purifier.

<p>Q4. The air quality is still poor after using the air purifier.</p>	<p>* Please make sure the air inlet and air outlet of the air purifier are not blocked by any objects. Leave 38 cm/15 inches of clearance on all sides of the air purifier.</p>
	<p>* Please check if the pre-filters are clogged by some large particles, such as hair or lint. If yes, please clean the pre-filters.</p>
	<p>* Replace the HEPA&Activated Carbon Filter.</p>
<p>Q5. The Filter Replacement Indicator is still on after I replace the HEPA&Activated Carbon Filter with a new one.</p>	<p>* After replacing the filter, please long press  for 3s until the indicator flashes 3 times to reset the service time.</p>
<p>Q6. The Filter Replacement Indicator is still off after I use the air purifier for 6 months, or it lights up less than 3 months after use.</p>	<p>* The indicator is to remind you to check the HEPA&Activated Carbon Filter. It lights up depending on the use frequency of the air purifier and the air quality. If you don't use your air purifier often, it will take longer to light up. If you use it frequently, it will take shorter to light up.</p>
<p>Q7. The touch panel isn't working.</p>	<p>* Ensure the Child Safety Lock is turned off.</p>
	<p>* The air purifier is malfunctioning. Please contact us.</p>
<p>Q8. Where to buy HEPA&Carbon Activated Filters?</p>	<p>* Please contact us to get the purchase link, Thanks.</p>
<p>Q9. Air Quality Indicator always stays blue, even when the air quality is poor.</p>	<p>The Infrared Sensor detects airborne particles, but it cannot detect gas. Make sure there isn't gas polluting the air.</p>
<p>Q10. Display shows Error Code "E1".</p>	<p>Please check Filter cover is properly installed.</p>

If your problem is not listed, please contact **Customer Support**.



CUSTOMER SUPPORT

support@welovhome.com

www.welovhome.com